

TOPIC: HEAT

General Objectives:

The learner should be able to use the knowledge of thermometry in calibration of thermometers and explain modes of transfer of heat.

SUB-TOPIC: TEMPERATURE

SPECIFIC OBJECTIVES

The learner should be able to;

- (i) Define temperature.
- (ii) Measure temperature
- (iii) Convert temperature from the Kelvin scale to Centigrade scale and vice versa.
- (iv) Define the fixed points.
- (v) Carry out experiments to determine the fixed point of a thermometric scale.

TEMPERATURE

This is a number expressing the degree of hotness or coldness of a substance on some scale.

(In other words it is the intensity of heat).

The particles of matter are always moving randomly. The **energy due to motion** is known as the **kinetic energy**.

Temperature is the measure of the average kinetic energy of the molecules. The temperature of a substance is low if the molecules are moving slowly and high if the molecules are moving very high.

It is **measured by an instrument** known as a **thermometer**

The **SI unit** of temperature is **kelvin (K)** named after a physicist Lord Kelvin.

The commonly used unit for measuring temperature is **degree celsius ($^{\circ}\text{C}$)**.

Celsius and kelvin scales.

The lowest possible temperature that can be reached is called the **absolute zero temperature**.

Any matter whose temperature is above this temperature, has heat energy.

Experiments on gases show that absolute zero is approximately -273°C on Celsius temperature scale.

On Kelvin temperature scale the absolute zero is zero kelvin (0K)

To convert temperature from celsius scale ($^{\circ}\text{C}$) to kelvin scale temperatures (in K), we add 273 to the celsius scale temperature.

$$\begin{aligned} \text{Temperature in } K &= \text{Temperature in } ^{\circ}\text{C} + 273 \\ \text{Temperature in } ^{\circ}\text{C} &= \text{Temperature in } K - 273 \end{aligned}$$

System developed by -- lule -- 0752697211, info@schoolporto.com

Relationship between the kelvin scale and the centigrade scale are shown in the below.

| | |
|------------------------|---------------------|
| $^{\circ}\text{C}$ | K |
| 100°C | 373K |
| $x^{\circ}\text{C}$ | $(x + 273)\text{K}$ |
| 0°C | 273K |
| -273°C | 0K |

Examples

- Express the room temperature 27°C in kelvin.
- Convert 327K to Celsius scale.
- Convert the following temperature readings to Celsius scale.
(a) 1010 K (b) 233 K (c) 373 K
- Convert the following temperature readings to Kelvin scale.
(a) 240°C (b) 30°C (c) 120°C

FIXED POINTS

Fixed points can be described as a single temperature at which a particular physical event always takes place.

We shall mainly look at two fixed points namely;

- Lower fixed point (ice point)
- Upper fixed point (steam point)

(i) LOWER FIXED POINT (ICE POINT)

This is the **temperature of pure melting ice at standard atmospheric pressure.**

It is 0°C on a Celsius scale and 273K on a kelvin scale.

An experiment to determine the Lower Fixed Point of an uncalibrated.

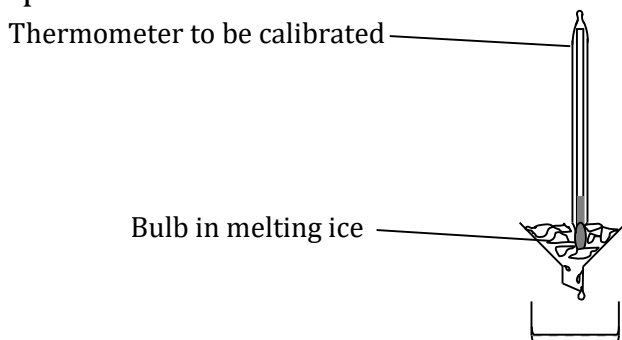

The bulb is completely immersed inside a glass funnel containing pure melting ice as shown in the diagram above.

Sufficient time is allowed for mercury to attain the temperature of the melting ice.

When there is no more change in the level of mercury, its position is marked on the stem.

This mark gives the lower fixed point.

(ii) UPPER FIXED POINT (STEAM POINT)

This is the **temperature of pure boiling water at standard atmospheric pressure.**

It is 100°C on a Celsius scale and 373K on a kelvin scale.

Powered by: www.schoolporto.com

System developed by -- luje -- 0752697211, info@schoolporto.com

An experiment to determine the upper fixed Point of an uncalibrated.
A hypsometer is used.

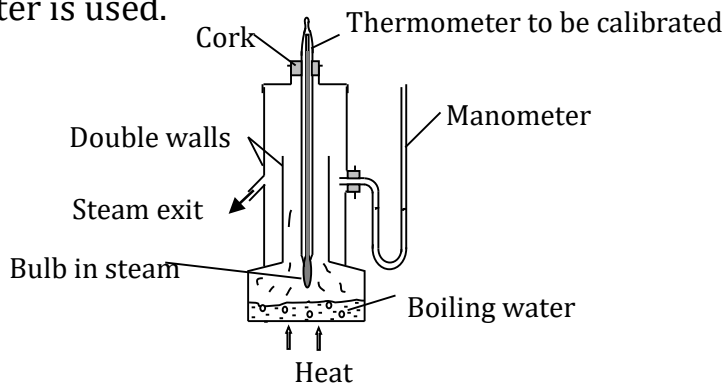

A hypsometer is a double-walled copper can.

Some water is poured in the hypsometer.

The thermometer to be calibrated is inserted through the hole of a cork.

The hypsometer is covered with the cork carrying the thermometer as shown in the diagram above.

Water is steadily boiled to generate steam that surrounds the bulb.

Sufficient time is allowed for mercury to attain the temperature of steam.

When there is no more change in the level of mercury, its position is marked on the stem.

This mark gives the upper fixed point.

- Note: (i) The bulb of the thermometer should NOT be allowed to dip into the boiling water. This is because water may not be pure and therefore, it may be boiling at a different temperature from that of the steam.
(ii) The double walls reduce loss of heat.
(iii) The manometer tests the equality of the pressure inside to the atmospheric pressure.

For a Celsius scale, the space between the lower and the upper fixed points known as the **fundamental interval** is divided into 100 equal spaces each representing 1°C with the lower mark given a value 0°C .

Calculating the temperature values when the lengths of the thermometric liquid for the lower and upper fixed points are given

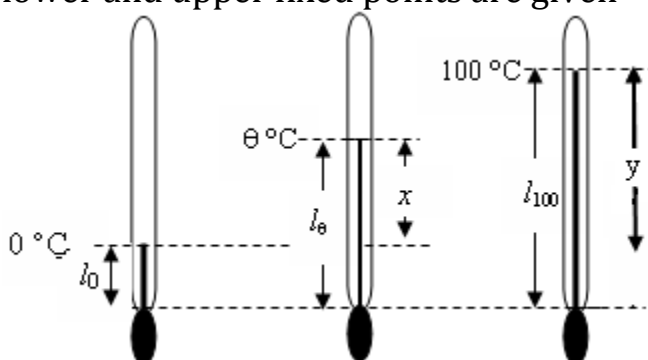

From the diagram:

l_0 = the length of mercury column at 0°C .

l_{100} = the length of mercury column at 100°C .

l_{θ} = the length of mercury column at unknown temperature, $\theta^{\circ}\text{C}$.

System developed by -- lule -- 0752697211, info@schoolporto.com

$$x = (l_{\theta} - l_0)$$

$$y = (l_{100} - l_0)$$

$$\text{Temperature, } \theta = \frac{\text{Length of thread from ice point}}{\text{Length of the fundamental interval}} \times 100^\circ\text{C}$$

$$\theta = \frac{l_\theta - l_0}{l_{100} - l_0} \times 100^\circ\text{C}$$

$$\theta = \frac{x}{y} \times 100^\circ\text{C}$$

Numerical Examples:

1. The length on the stem of a mercury-in-glass thermometer between the lower and upper fixed points is 18 cm. When the bulb of this thermometer is dipped in a liquid the mercury level in the stem is found to be 10 cm above the lower fixed point. What is the temperature of the liquid?
2. The length on the stem of a mercury-in-glass thermometer between the lower and upper fixed points is 18 cm. How far above the ice point will the mercury level be when the bulb is in a region at a temperature of 45°C ?

Solution:

$$(i) \quad \text{Temperature} = \frac{\text{Length of thread above ice point}}{\text{Length of the fundamental interval}} \times 100^\circ\text{C}$$

$$\therefore \theta = \frac{10}{18} \times 100 = 55.6^\circ\text{C}$$

$$(ii) \quad \frac{\text{Length of thread above ice point}}{\text{Length of the fundamental interval}} = \frac{\text{Temperature}}{100}$$

$$\therefore \text{Length of thread above ice point} = \frac{45}{100} \times 18 = 8.1 \text{ cm}$$

3. The length on the stem of a mercury-in-glass thermometer between the lower and upper fixed points is 18 cm.
 - (i) When the bulb of this thermometer is dipped in a liquid the mercury level in the stem is found to be 10 cm above the lower fixed point. What is the temperature of the liquid?
 - (ii) How far above the ice point will the mercury level be when the bulb is in a region at a temperature of 45°C ?

Solution:

$$(i) \quad \text{Temperature} = \frac{\text{Length of thread above ice point}}{\text{Length of the fundamental interval}} \times 100^\circ\text{C}$$

$$\therefore \theta = \frac{10}{18} \times 100 = 55.6^\circ\text{C}$$

$$(ii) \quad \frac{\text{Length of thread above ice point}}{\text{Length of the fundamental interval}} = \frac{\text{Temperature}}{100}$$



Powered by: www.schoolporto.com

0752697211 | info@schoolporto.com

$$\therefore \text{Length of thread above ice point} = \frac{45}{100} \times 18 = 8.1 \text{ cm}$$

Temperature Scales – calibration of a thermometer

To measure temperature, a temperature scale must be established. This is done in the following steps:

1. Selection of some **thermometric property/substance whose value varies continuously with temperature.**

Some examples of thermometric properties are:

(Also known as **physical properties which change with temperature**)

- Volume of a liquid
 - Pressure of a fixed mass of gas at constant volume.
 - Volume of a fixed mass of gas at constant pressure.
 - Thermoelectric emf
 - Electrical resistance of a pure metal
2. Choice of a suitable instrument in which to observe the property.
 3. Choice and determination of two fixed points – the upper and lower fixed points
 4. Subdivision of the fundamental interval into 100 divisions (for a Celsius scale)
 5. For a Celsius scale the space between the two marks on the stem is divided into 100 equal spaces each representing 1°C with the lower mark given a value 0°C.

The difference between the two fixed points is known as the **fundamental interval**.

SUB-TOPIC: THERMOMETERS.

- List types of thermometers e.g. liquid-in-glass, gas and digital thermometers.
- Compare different types of thermometers.
- Compare thermometric liquids. Carry out experiment to calibrate a thermometer.
- Explain the working of a clinical thermometer.
- Use a clinical thermometer.

THERMOMETERS

A thermometer is an instrument used for measuring temperature.

There are various types thermometers in use. The liquid in glass thermometer is most common one. The others include;

- Electrical thermometer
- Digital thermometer
- Gas thermometer

The main difference between them is in the property of the thermometric substance. We shall discuss liquid in glass thermometers only.

Liquid in glass thermometers

A liquid in glass thermometers uses either mercury or coloured alcohol as the thermometric substance.



System developed by -- lule -- 0752697211, info@schoolporto.com

DIAGRAM OF A WELL LABELLED LIQUID IN GLASS THERMOMETER.

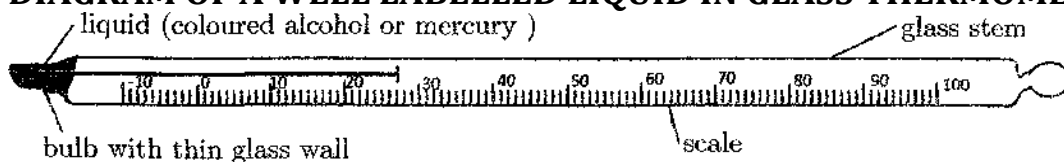

HOW TO USE A THERMOMETER?

When using a thermometer, the bulb is kept in contact with the body whose temperature is to be measured. Sufficient time is given for mercury level in the tube to become steady. The thermometer reading is the temperature of the body.

IMPORTANT PRECAUTIONS TAKEN IN THE CONSTRUCTION OF LIQUID IN GLASS THERMOMETER.

1. **The walls of the bulb are thin.**
This ensures that the mercury can be heated easily.
2. **The quantity of mercury the bulb is small.**
This ensures that the mercury takes little time to warmup.
3. **The thin capillary tube is of a uniform cross-section.**
This ensures that the mercury level changes uniformly along the capillary tube.
4. **The capillary tube is narrow or fine.**
This makes the thermometer very sensitive and therefore it can detect very small changes in temperature.
5. **The glass wall is thick.**
This ensures that the inner parts of a thermometer are well protected.

Note: The space above mercury is usually evacuated to avoid excess pressure from being developed when mercury expands.

NB: Water cannot be used as a thermometric liquid because

- (i) it exhibits anomalous expansion.
- (ii) it freezes at 0°C and boils at 100°C , i.e it has a rather narrow temperature range in which it exists as a liquid.
- (iii) it has high specific heat capacity
- (iv) it is transparent and sticks to glass

Choice of a liquid for Thermometers

This depends on the range over which temperature is to be measured. For example where the temperatures go for below ice point alcohol is preferred since it freezes at -115°C and boils at 78°C .

Examples of thermometric substances

- Alcohol
- Mercury
- Oil of creosote

Note:



Powered by: www.schoolporto.com
System developed by -- lule -- 0752697211, info@schoolporto.com

In mercury –in- glass thermometer, the thermometric substance is used is mercury and the property is volume of mercury.

In platinum resistance thermometer, the property is uniform increase in resistance of platinum.

Properties of thermometric liquids

A thermometric liquid should have the following properties:

- (i) Should be opaque for easy reading.
- (ii) Good conductor of heat.
- (iii) High and uniform expansivity.
- (iv) High boiling point.
- (v) Low freezing point and
- (vi) Should not wet glass.

Comparison between mercury and alcohol

| Mercury | Alcohol |
|---|---|
| (i) Opaque and therefore can easily be read | - Not opaque but can be coloured. |
| (ii) Good conductor of heat therefore sensitive to small temperature changes. | - Poor conductor of heat therefore not so sensitive to small temperature changes |
| (iii) Has uniform expansivity | - Expansion not so regular |
| (iv) Has high boiling point (357 °C) and therefore can measure high temperatures without turning to vapour. | - Low boiling point (78 °C) and therefore not suitable for measuring high temperatures because it vaporizes easily. |
| (v) Not very low freezing point (-39 °C) therefore can not measure temperatures below its freezing point. | - Low freezing point (-115 °C) |
| (vi) Does not wet glass | - Wets glass |

Advantages of alcohol over mercury as thermometric liquid

1. It has higher expansivity (about six times) that of mercury.
2. It has lower freezing point than mercury. Alcohol freezes at -115 °C while mercury freezes at -39°C. The high freezing point of mercury makes the measurement of temperatures lower than -39°C to be impossible.

Apart from this disadvantage, mercury is preferred to alcohol for the following reasons.

- (i) It is a better conductor of heat than alcohol and therefore responds more readily to changes in temperature.
- (ii) It is opaque and makes reading easy.
- (iii) It has a high boiling point, -357°C and whereas alcohol has low boiling point, 78°C , can easily vaporize to fill  per part with vapour.

Powered by: www.schoolporto.com

System developed by -- lule -- 0752697211, info@schoolporto.com

Reasons why water is not used as a thermometric liquid

Water is unsuitable for use in thermometers because of the following reasons.

- (i) It freezes at 0°C .
- (ii) It has irregular expansion.

Special Thermometers

1. The Clinical Thermometer

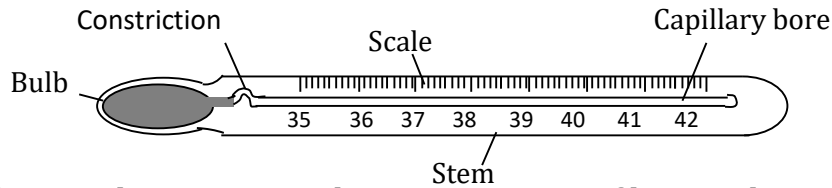

It is designed to measure the temperature of human beings. The range of this thermometer is small i.e $35^{\circ}\text{C} - 42^{\circ}\text{C}$ because the human body temperature cannot lie outside this range.

Such a short range makes the scale very sensitive since a single degree on it is large enough to be subdivided.

The high sensitivity on this thermometer is achieved by manufacturing it with a large bulb and a narrow bore.

The **constriction/kink** near the bulb prevents mercury from flowing back before the temperature is read.

It is **not** advisable to **sterilize** this thermometer in boiling water, since this would require the mercury to expand far beyond the space provided in the bore; this would just burst the bulb.

Note:

The clinical thermometer has a **bulge** in the glass. It is more triangular in shape than the common mercury thermometer.

The **bulge acts as a lens**, making it **easier to see** the narrow thread against the scale.

How it is used?

The thermometer is placed under the patient's armpit or under the tongue for about 2 minutes to ensure that it fully acquires the patient's body temperature. It is then withdrawn and the temperature is read off from the position of the mercury thread.

Before it is used again, the mercury has to be returned to the bulb by **shaking**.

Six's Maximum-Minimum Thermometer

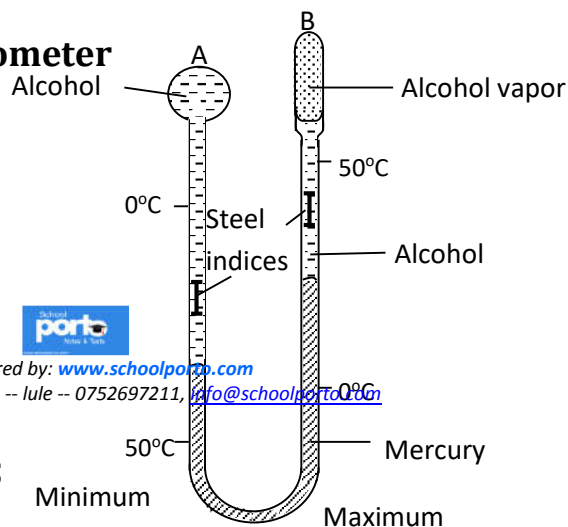

It is used to record the maximum and minimum temperatures during a day. Here the thermometric liquid is alcohol contained in bulb A. When the temperature rises, the alcohol in bulb A expands forcing the mercury round and pushing the steel index in right hand limb up. This index records the maximum temperature reached. Bulb B contains saturated alcohol vapour, some of which condenses as it is compressed. When the temperature falls, the alcohol in bulb A contracts. This causes the mercury in bulb A to contract making the mercury in the left hand side to rise thereby pushing up the steel index there. This index records the minimum temperature reached. The indices can be reset to the mercury menisci once again by using a magnet.

OTHER THERMOMETERS INCLUDE

- (i) Thermocouple
- (ii) Resistance thermometer
- (iii) Thermistor
- (iv) The constant-volume gas thermometer

The Thermodynamic Temperature Scale

This scale has only one fixed point – the **triple point of water**. It is independent of the properties of the substance used in the thermometer.

The other scales are dependent on the properties of the substance used and therefore different thermometers using different properties may give different readings for the same temperature except at the fixed points.

Definition

The triple point temperature is temperature and pressure at which the liquid, solid, and gaseous states of a substance coexist in equilibrium. The **triple point** of pure water is at 0.01°C

On the thermodynamic scale the temperature is measured in kelvin (K). The ice point is about 273K. The temperature on this scale is known as the **absolute temperature**.

The zero of this scale is the **absolute zero**, which is theoretically the lowest possible temperature. It is assumed that at the absolute zero a substance has lost all heat.

Test Yourself

1. Define each of these: temperature, thermometer.
2. List the steps involved in establishing a temperature scale.
3. What is the absolute zero of temperature?
4. For a liquid-in-glass thermometer, what are the governing factors for choosing the liquid to be used?
5. Why is water NOT suitable as a thermometric liquid?
6. In what circumstances could an alcohol thermometer be preferred to a mercury one?
7. On the hypsometer, what is the  the manometer? Why should the bulb of the thermometer not dip in the boiling water?

Powered by www.schoolporto.com
System developed by -- lule -- 0752697211, info@schoolporto.com

8. When determining the lower fixed point of a mercury-in-glass thermometer, why should the ice be contained in a funnel and not in a beaker?
9. What is meant by sensitivity of a thermometer?
10. How would you increase the sensitivity of a liquid-in-glass thermometer?
11. Explain the fact that a thermometer may be quick-acting and yet not very sensitive.
12. Why is the range of a clinical thermometer usually $35^{\circ}\text{C} - 42^{\circ}\text{C}$?
13. What is the use of the constriction on a clinical thermometer?
14. Why are the indices of a Six's thermometer made of steel and not any other metal like copper?

TOPIC: HEAT TRANSFER

SUB-TOPIC: Conduction

SPECIFIC OBJECTIVES

The learner should be able to;

- Define conduction.
- List the factors affecting rate of conduction.
- Carry out experiments to compare good and bad conductors.
- Carry out an experiment to show that water is a poor conductor of heat.
- Explain applications of conduction.

HEAT

Heat is a form of energy that flows from body to another due to a temperature difference between them.

Or

Heat is a form of energy that passes from a body of high temperature to a body of low temperature.

The SI unit of energy is joule (J)

MODES OF HEAT TRANSFER

There are three modes of heat transfer namely;

- (a) Conduction
- (b) Convection
- (c) Radiation

CONDUCTION

This is heat transfer by means of a stationary material medium due to temperature difference.

Or

This is heat transfer from a region of high temperature to a region of low temperature with no visible movement of the particles.

Conduction occurs mainly in solids but it takes place in all states of matter.

Most metals are good conductors of heat, silver being **the best** followed by copper.

A metallic chair feels colder than a wooden one in same room. This is because the metal of the chair is a better conductor of heat than wood so it conducts away heat from the user's body much faster.

Concept/mechanism of conduction of heat.

The molecules of metal near the heat source receive heat energy and begin to vibrate. These molecules collide against the neighboring molecules and agitate them. The agitated molecules, in turn, agitate the molecules in the next layer and so on until the molecules at the other end are agitated. Therefore, the heat is passed from one end to another till the other end becomes hot.

Hence, in conduction, energy transfer takes place by vibration of the molecules. There is no actual movement of the heated particles.

Factors that affect heat transfer by conduction.

- **Temperature difference between the ends.**
The higher the temperature difference the higher the heat transfer.
- **The nature of the materials (thermal conductivity of the material)**
Some materials are good conductors of heat while others are poor conductors of heat.
- **The cross-section of the material (thickness of the material)**
More heat is transferred through thick materials than in thin ones at the same time.
- **The length of the conductor**
Heat energy transferred through a material of smaller length is higher than heat through a longer material at the same time.

GOOD CONDUCTORS AND POOR /BAD CONDUCTORS.

A good conductor is a substance which has the ability to transfer heat through itself easily. eg most metals

A poor conductor is a substance which doesn't allow heat to pass through it easily. eg water, air, glass, wood, plastic, paper etc

Poor/bad conductors are sometimes referred to as insulators.

An experiment to demonstrate that wood is a poor conductor of heat.

Close paper collar

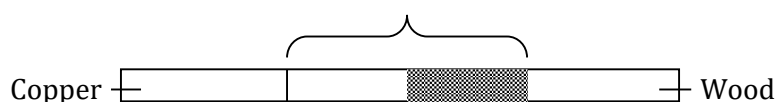

A piece of paper is tightly wrapped round the joint so that it covers the copper and wood equally.

The rod is passed several times through a bunsen flame.

Observation:

The part of the paper on the wood gets charred (partially burnt) while that over copper remains unharmed.

Explanation



Powered by: www.schoolporto.com
System developed by -- lule -- 0752697211, info@schoolporto.com

Copper conducts away heat from the paper much faster than the wood does. So the temperature of the paper over copper remains low while that of the paper over wood rises.

Effects of a Good Conductor near a Flame

Wire gauze is placed about 5cm above the burner and the gas is turned on. If it is lit underneath the gauze, the flame does not pass through the gauze. If instead the gas is lit above the gauze after the gauze has cooled, the flame remains on top.

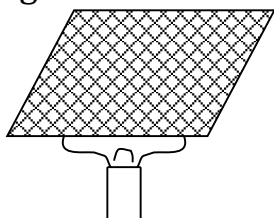

(i) The flame fails to pass through the gauze

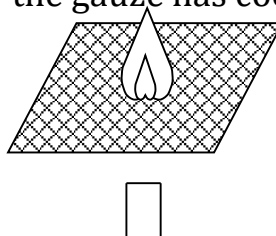

(ii) The flame stays on top of the gauze

Explanation:

In case (i) the gauze conducts away heat from the region of the gauze so fast that the gas above it is cooled below ignition point.

In case (ii) the rapid conduction by the gauze keeps the gas in contact with the underneath below ignition point. This behavior was applied in the **Davy Safety lamp**

Experiment: To show that Water is a poor conductor of heat.

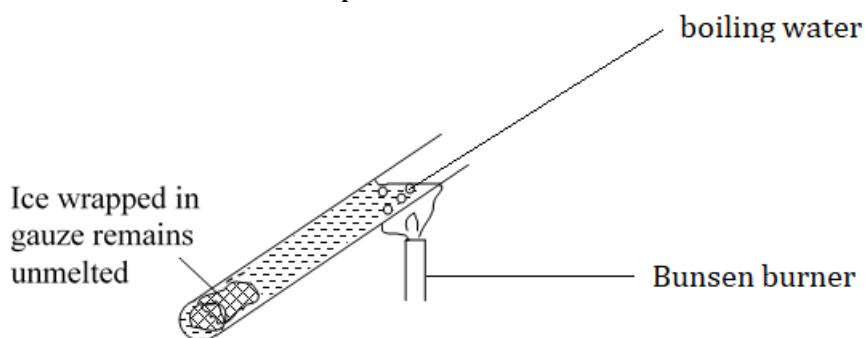

Ice is wrapped in wire gauze and placed in a test tube.

The test tube is then filled with water.

The gauze helps the ice to sink to the bottom.

The water is heated near the top.

The water boils locally while ice at the bottom remains unmelted.

This shows that heat could not sufficiently be conducted from the top to the bottom by the water.

Note:

Ice is kept at the bottom to eliminate convection from participating.

An experiment to Show that Mercury is a better Conductor of Heat than Water.

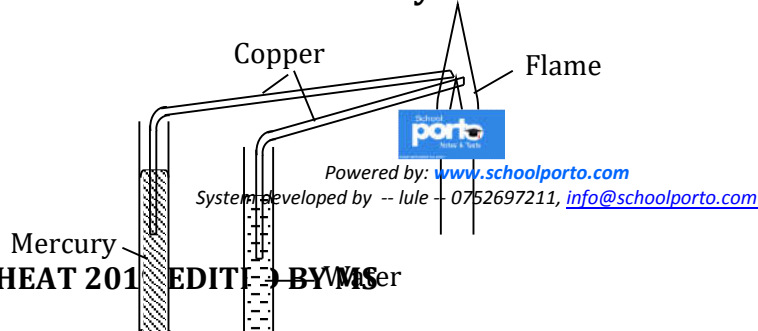

Two test tubes are filled with equal volumes of mercury in one tube and water in the other.

A cork is attached to the bottom of each using wax.

The test tubes are held vertical in stands.

Thick identical copper rods are bent and one end of each is dipped into one of the liquids while the free ends are brought together in a flame

In a very short time the wax on the mercury-filled tube melts and the cork falls off while that on the water-filled one remains for a very long time.

Since heat is equally conducted to each liquid by the copper rods, mercury is a much better conductor of heat.

Comparison of Thermal conductivities of Solids

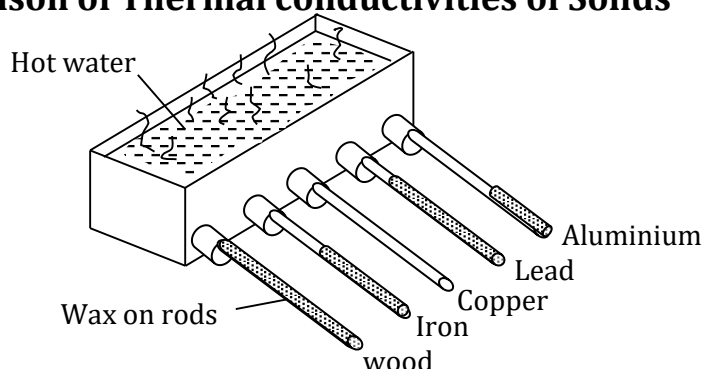

Rods of different materials but of the same dimensions are passed through corks inserted in holes in the side of a metallic vessel.

The rods are coated with wax.

Boiling water is poured into the vessel to heat the ends of the rods equally.

After sometime it is observed that wax melts to different distances along the rods.

Which metal does the above set-up show to be the best conductor?

Uses/Applications of Conduction of Different Materials

Both good and bad conductors of heat have useful applications.

1. In situations where heat loss or gain is to be prevented, a poor conductor is used as insulators- e.g in fridges, ovens, water heaters, etc.
2. In electric iron box, the flat metal base is used to press clothes because it is a good conductor.

A plastic handle is used to insulate the heat from the base to the handle since plastic is a poor conductor of heat.

Similarly, all handles of heating appliances are made of poor conductors.

3. Air is used as a poor conductor



The air molecules **trapped** in the knitted wool do not conduct heat from our bodies to the outside. This is why woollen garments are commonly worn in cold weather to keep our bodies warm.

Similarly, blankets, fur coats and feathers are good insulators because of the **trapped air**.

The process of using material of low conductivity for preventing heat transfer is called **lagging**.

Question: Why are woollen materials bad conductors of heat?

SUB TOPIC: CONVECTION

SPECIFIC OBJECTIVES

The learner should be able to;

- Define convection.
- Describe how convection current is formed.
- Experimentally demonstrate convection current.
- Describe application of convection

CONVECTION

This is heat transfer in a fluid by actual physical movement of the molecules from a region of high temperature to a region of low temperature.

Experiments to investigate heat transfer in fluids (liquids and gases)

(a) **An experiment to observe convection currents in water.**

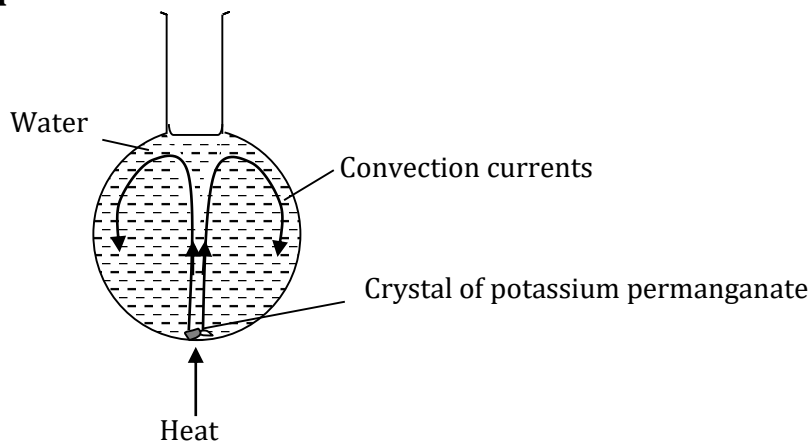

A glass flask is filled with clear water up to the neck.

Using a glass tube, a few crystals of potassium permanganate are placed at the bottom of the flask.

The water is gently heated at the bottom.

Observation

Colored streaks are seen to rise from the bottom to the top.

Explanation

When the portion of the liquid at the bottom is heated, it expands, becomes less dense and rises to the top. The cooler and denser liquid flows to replace the risen liquid. So the liquid circulates in the container and forms currents. This continues until all the liquid boiled.

(b) **An experiment to observe convection currents in air.**



A box with a glass front and two chimneys fixed at the top is obtained.
 A lit candle is placed at the base of one of the chimneys.
 A smouldering piece of paper is placed above the edge of the other chimney.

Observation

It is observed that smoke is drawn down the chimney and expelled via the one above the candle.

Explanation

The air above the candle is heated, it expands and so it becomes less dense and rises. It is replaced by the cold dense smoke from the smouldering paper, which is also heated in turn and rises.

The smoke particles from the smouldering paper enable us to see the path of convection currents.

APPLICATIONS OF CONVECTION.

1. WINDOWS AND VENTILATORS IN BUILDINGS.

Ventilation is an application of convection.

It is a process of providing cool fresh air to an enclosure e.g a room or building.

When a room is heated up by the occupants, the less dense warm air rises, escaping through the ventilators, and is replaced by the denser fresh air flowing through the windows.

Question:

1. Why are ventilators constructed above windows and doors?
2. How does a chimney make life more comfortable in the kitchen?

2. The Domestic Hot-water Supply System.

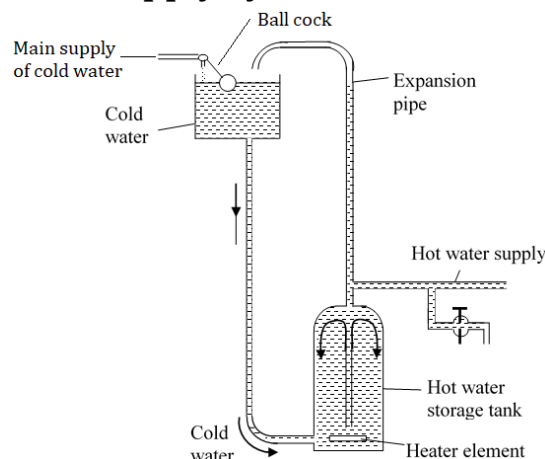

Less dense hot water rises to the top of the hot water storage tank.

The hot water to the taps is drawn from the top of the hot water storage tank. The denser cold water enters at the bottom of the tank to replenish (fill up the tank again).

The water heated keeps on rising to the top.

The expansion pipe provides room for the heated water to expand into it and also permits dissolved air to escape.

3. Electrical devices

(i) Electric kettles have their heating coil at the bottom.

When the **element** is at the **bottom**, one can boil any amount of water that will cover the **element**. Hot water is less dense than cold water, so hot water rises from a hot **element** to the top of the water and the denser cold water moves down, this sets up convectional currents which make the water to boil uniformly.

(ii) The refrigerators have their freezing unit at the top.

This is based on the principle of convection currents. What happens is that due to the **cooling**, the air becomes denser and moves downward. This creates a partial vacuum above, which is replaced by the warmer air from the bottom, which also gets **cooled** by the **unit**.

Effects of Convection

(i) Wind

(ii) Land and sea breezes

Land and Sea Breeze

A breeze is a gentle wind.

(i) Sea breeze

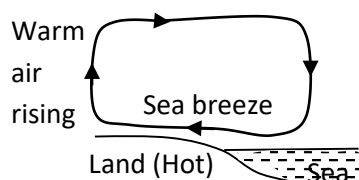

(i) Sea breeze (During day)

During the day, the temperature of the land rises faster than the temperature of the sea water and the air above the land becomes warmer than the air above the sea water. The warm less dense air rises from the land, allowing the cold dense air over the sea to blow to the land.

This creates a sea breeze in the day time.

(ii) Land breeze

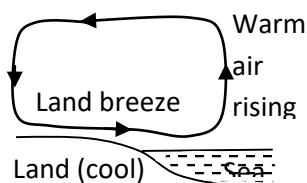

(ii) Land breeze (At night)

At night the land cools rapidly faster than the sea water.

The land becomes cool while the sea remains warm.

Therefore, warm air over the sea rises while cool air blows from the land to replace it. This sets up a land breeze.



Radiation is the mode of heat transfer from one place to another without affecting the intermediate medium.

This is heat transfer by electromagnetic waves.

No material medium is required.

Similar to Light, heat from the sun reaches the earth by radiation. It travels in the same way as light does and behaves in many ways like light. For example, a lens converges heat in the way it does to light.

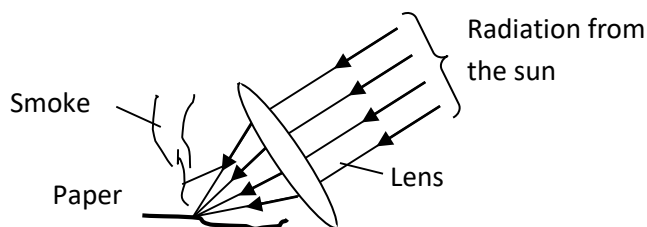

On a sunny day, when a converging lens is held in sunshine above a piece of paper at a height such that a bright spot appears on the paper, the paper begins to smoke after a short time.

This shows that the lens converges heat to the same spot as it does light.

An experiment to demonstrate radiation.

Dull black tin plate

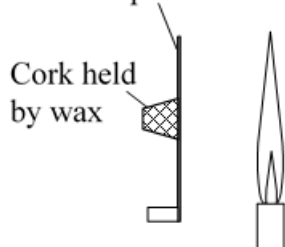

A tin plate is painted black on one side.

A cork is stuck on the other side with melted wax.

A Bunsen burner flame is kept close to the painted side.

The wax melts and the cork falls off.

Note:

- The surfaces of all luminous bodies emit radiation. Human face also emits mild radiations.
- While conduction and convection need a medium to be present for their transfer, radiation can take place without a medium.
- The amount of heat energy radiated depends upon the temperature of the body.

Absorption by different surfaces

An experiment to illustrate good and bad absorbers.

Dull black tin plate

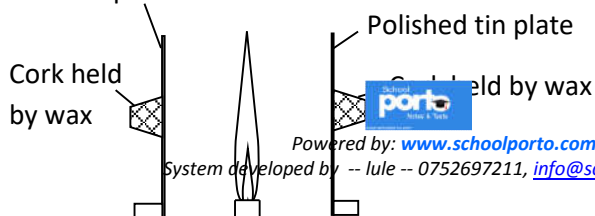

Powered by: www.schoolporto.com

System developed by -- lule -- 0752697211, info@schoolporto.com

Two sheets of tin plate, one polished and the other dull black, are set up vertically a short distance apart.

A cork is fixed on the back side of each by means of wax.

A burner is placed midway between the plates.

observation

The wax on the back of the dull black plate melts and the cork falls while that on the polished plate remains.

Conclusion

The dull black plate must have absorbed heat faster than the polished one. So, dull black surfaces are better absorbers than polished ones.

Radiation/emission by Different Surfaces

An experiment to illustrate good and bad emitters/ radiators.

Galvanometer (an instrument for detecting and measuring small electric currents.)

Thermopile (an electronic device that converts thermal energy into electrical energy)

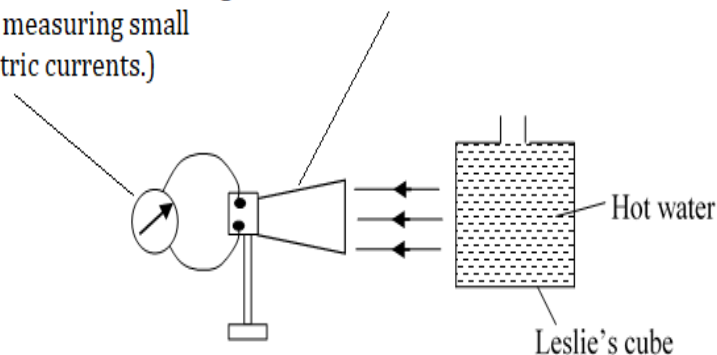

A hollow copper cube, each side of which has a different surface (black, white or shiny) is filled with hot water.

A thermopile is placed at the same distance from each face in turn while observing the deflection of the galvanometer.

Observation

The deflection is greatest when the thermopile is facing the dull black side, and least when facing the polished shiny side.

Conclusion

Rough, dull black surfaces are good emitters/radiators while smooth shiny ones are poor radiators.

Note: In general;

- Dull black surfaces are good absorbers and also good emitters of heat.
- Shiny surfaces are poor absorbers and also poor emitters of heat.

Factors that affect radiation.

- (i) its temperature
- (ii) nature of its surface
- (iii) surface area

Applications of radiation

1. The Vacuum Flask



Powered by: www.schoolporto.com

System developed by -- lule -- 0752697211, info@schoolporto.com

The vacuum flask or thermos flask is designed to either keep cold things cold or hot things hot.

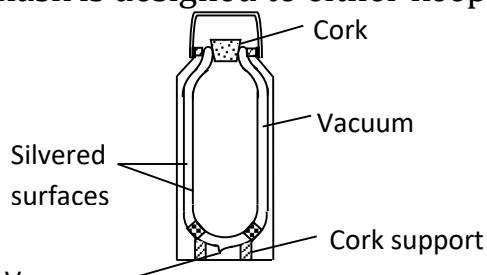

The flask operates by using the following parts.

| PART | FUNCTION |
|-------------------|--|
| Vacuum | To minimise heat transfer by convection and conduction |
| Silvered surfaces | To minimise heat transfer by radiation |
| Top cork | To minimise heat transfer conduction |

2. Solar energy.

The sun is the main source of solar energy for us and energy is utilised by scientists for many uses.

3. Solar heating. (read about solar heating on page 113 Longhorn book 1)

4. Solar concentrators.

Curved mirrors are used to concentrate the heat radiations from the sun to a small area to their focus.

5. Car radiator

The car engine produces a lot of heat when the car is moving. The car radiator is used to dissipate this heat through radiation.

The radiator is made of an aluminium pipe, bent several times to form a rectangle.

The multiple folding of the pipe increases the surface area of the radiator which in turn increases the rate of cooling.

The coolant usually water, flows through the pipes of the radiator, the heat is absorbed by the aluminium body of the radiator and it is dissipated by into the cool air blowing around it.

It also has an electric fan placed closed to the radiator blows cold air into the radiator to increase the cooling process.

Green House Effect

This is the process of allowing in radiation from the sun and preventing radiations emitted by the plants from escaping.



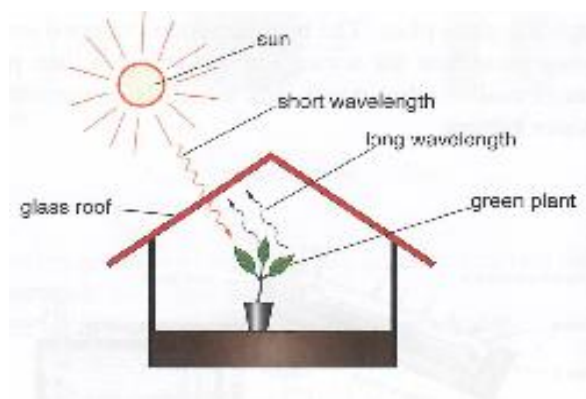

The sun and other hot bodies emit radiation of short wavelength. This radiation is able to enter the green house through the glass walls.

The objects inside the house absorb the radiation and have their temperature raised so that they also radiate heat.

But the radiation from the objects inside the house is of longer wavelength and therefore is unable to pass through the glass of the walls.

So the temperature inside the green house rises and the house feels warm.

Global Warming (Green House Effect)

The Earth's atmosphere behaves like a green house.

Radiation from the sun easily passes through the atmosphere and is absorbed by the earth.

The Earth warms up and re-radiates energy but of longer wavelength.

So the atmosphere, consisting of water vapor, carbon dioxide and other gases, absorbs this energy and re-radiates it back to the Earth.

Thus the Earth gets warmer than it would be.

Today global warming has become an important issue.

Test Yourself

1. Distinguish between heat and temperature
2. What is meant by each of the following modes of heat transfer?
- conduction, convection and radiation
3. Explain why a metallic chair feels colder than a wooden one in the same room.
4. In the copper-wood experiment to demonstrate difference in conductivities, explain why the paper wrapped round the wood gets charred first.
5. Explain why when gas from a burner is lit underneath a metallic wire gauze, the flame does not cross to the top of the gauze. Name one application of this behaviour.
6. In the experiment to demonstrate the poor conductivity of water, why is the ice wrapped in a wire gauze?
7. In order to warm a liquid, heat is applied at the bottom. Explain why.
8. Explain how a sea or land breeze comes about.
9. How would you show that heat radiation travels in the same way as light.
10. Explain why bodies of appliances that heat up as they work are perforated with holes.
11. What colour would you choose for a car radiator? Why?
12. Name the main parts of a vacuum flask stating the purpose each serves.

13. Why is global warming referred to as 'green house effect'?

THE END



Powered by: www.schoolporto.com
System developed by -- lule -- 0752697211, info@schoolporto.com