

GERSHIBON CHRISTIAN SCHOOLS

HOMEWORK FOR MIDDLE CLASS TERM 1

NUMBER – LEARNING AREA 4 (Week 1)

My name is

Copy number 1

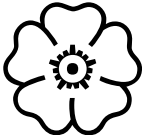

1

1

1

Copy number 2



2

2

2

2

GERSHIBON CHRISTIAN SCHOOLS

HOMEWORK FOR MIDDLE CLASS TERM 1

NUMBER – LEARNING AREA 4 (Week 2)

My name is

Copy number 3



3

3

3

Copy number 4

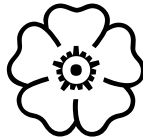
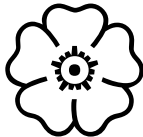
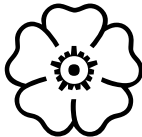
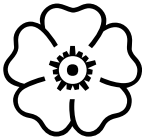

4

4

4

4

GERSHIBON CHRISTIAN SCHOOLS

HOMEWORK FOR MIDDLE CLASS TERM 1

NUMBER – LEARNING AREA 4 (Week 3)

My name is

Copy number 5



5

5

5

5

Copy numbers 0 - 5

0

1

2

3

4

5

GERSHIBON CHRISTIAN SCHOOLS

HOMEWORK FOR MIDDLE CLASS TERM 1

NUMBER – LEARNING AREA 4 (Week 4)

My name is

Match the same number and write

3

4 _____

5

1 _____

2

3 _____

0

5 _____

1

2 _____

4

0 _____

Cross the different number.

3

2

3

3

3

4

4

4

4

5

1

2

2

2

2

GERSHIBON CHRISTIAN SCHOOLS

HOMEWORK FOR MIDDLE CLASS TERM 1

NUMBER – LEARNING AREA 4 (Week 5)

My name is

Write the number correctly

5 _____

1 _____

9 _____

2 _____

3 _____

4 _____

7 _____

Circle the given number

4	3	2	4
5	4	5	3
3	3	2	5
2	4	1	2
1	0	1	3

GERSHIBON CHRISTIAN SCHOOLS

HOMEWORK FOR MIDDLE CLASS TERM 1

NUMBER – LEARNING AREA 4 (Week 6)

My name is

Count and match

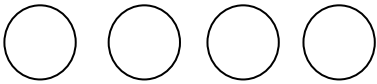

3

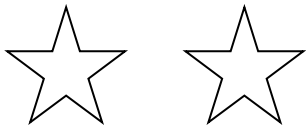

1

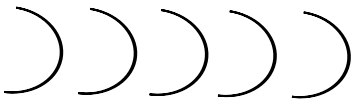

5

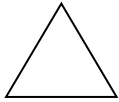

4

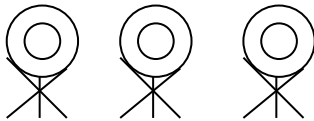

2

Shade circles of number 5

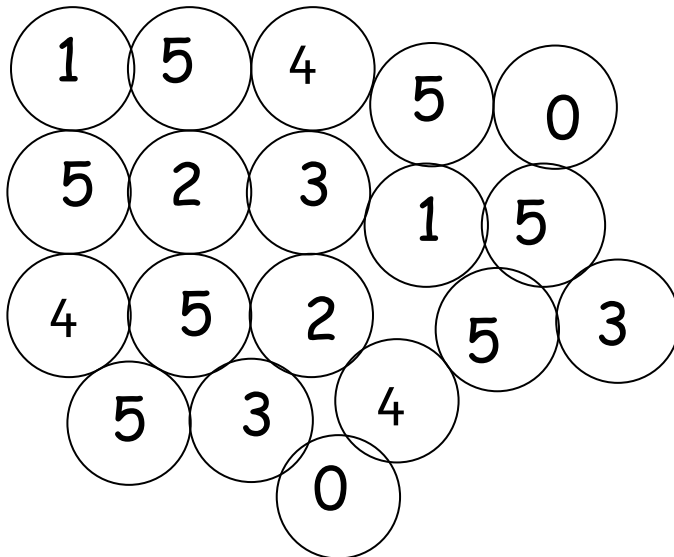

GERSHIBON CHRISTIAN SCHOOLS

HOMEWORK FOR MIDDLE CLASS TERM 1

NUMBER – LEARNING AREA 4 (Week 7)

My name is

Copy number 6

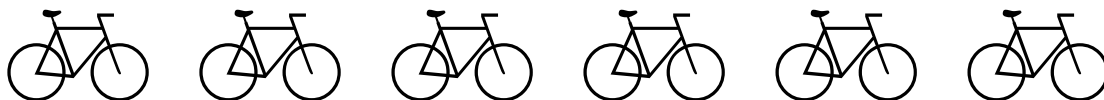

6

6

6

6

Draw balls for the number.

3 = 0 0 0

4 = _____

6 = _____

1 = _____

0 = _____

5 = _____

2 = _____

GERSHIBON CHRISTIAN SCHOOLS

HOMEWORK FOR MIDDLE CLASS TERM 1

NUMBER – LEARNING AREA 4 (Week 8)

My name is

Copy number 7

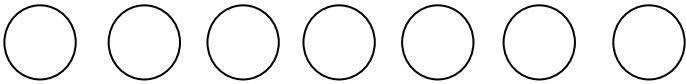

7

7

7

7

_____	_____	_____	_____
_____	_____	_____	_____
_____	_____	_____	_____
_____	_____	_____	_____

Count and write

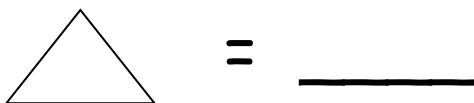
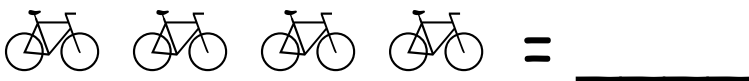
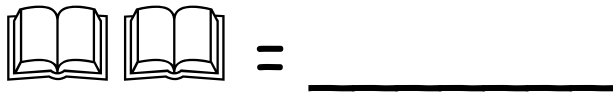
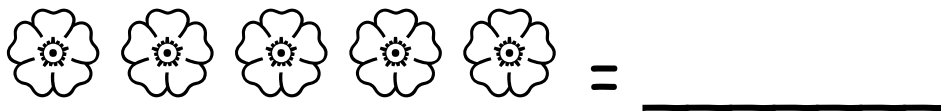
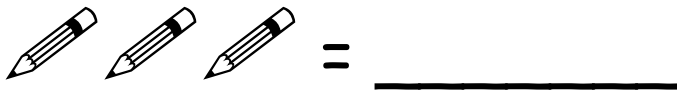

GERSHIBON CHRISTIAN SCHOOLS

HOMEWORK FOR MIDDLE CLASS TERM 1

NUMBER – LEARNING AREA 4 (Week 9)

My name is

Copy the numbers

6

7

8

9

10

Count and colour for the number.

7 = ○ ○ ○ ○ ○ ○ ○ ○ ○ ○

3 = △ △ △ △ △ △ △ △ △ △

8 = □ □ □ □ □ □ □ □ □ □

5 = ○ ○ ○ ○ ○ ○ ○ ○ ○ ○

9 = ▭ ▭ ▭ ▭ ▭ ▭ ▭ ▭ ▭ ▭

6 = ⊗ ⊗ ⊗ ⊗ ⊗ ⊗ ⊗ ⊗ ⊗ ⊗

2 = ☾ ☾ ☾ ☾ ☾ ☾ ☾ ☾ ☾ ☾

0 = ♡ ♡ ♡ ♡ ♡ ♡ ♡ ♡ ♡ ♡

4 = ♣ ♣ ♣ ♣ ♣ ♣ ♣ ♣ ♣ ♣

GERSHIBON CHRISTIAN SCHOOLS

HOMEWORK FOR MIDDLE CLASS TERM 1
NUMBER – LEARNING AREA 4 (Week 10)

My name is

Match the same and draw

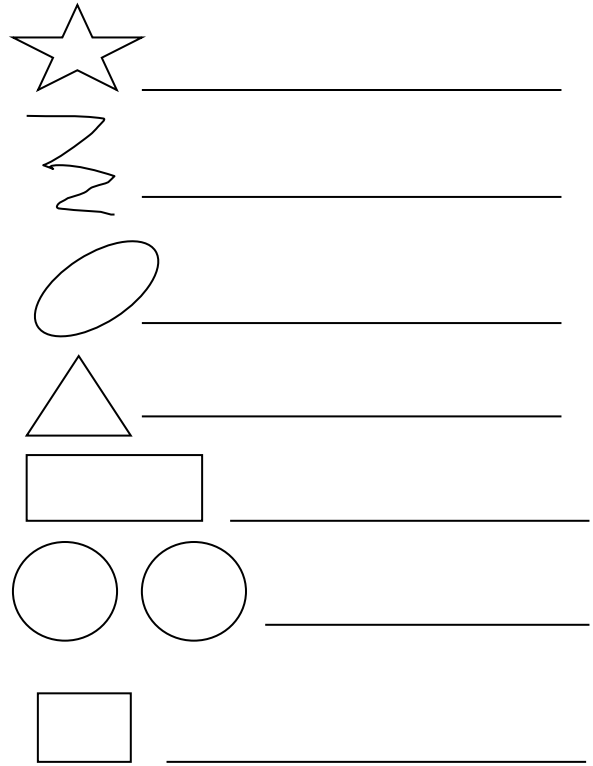
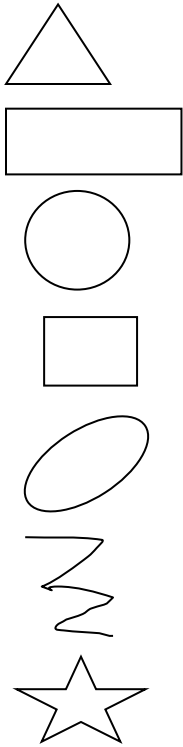

Draw balls for the number.

7 = _____

8 = _____

6 = _____

9 = _____

10 = _____

5 = _____

2 = _____

GERSHIBON CHRISTIAN SCHOOLS

HOMEWORK FOR MIDDLE CLASS TERM 1
NUMBER – LEARNING AREA 4 (Week 11)

My name is

Count and match

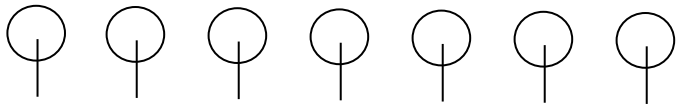

5



6

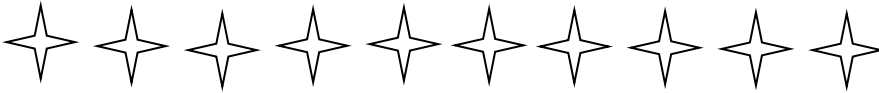

7



8

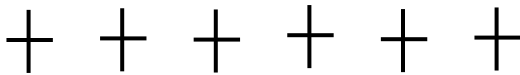

9

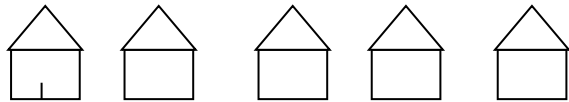

10

Shade the O's

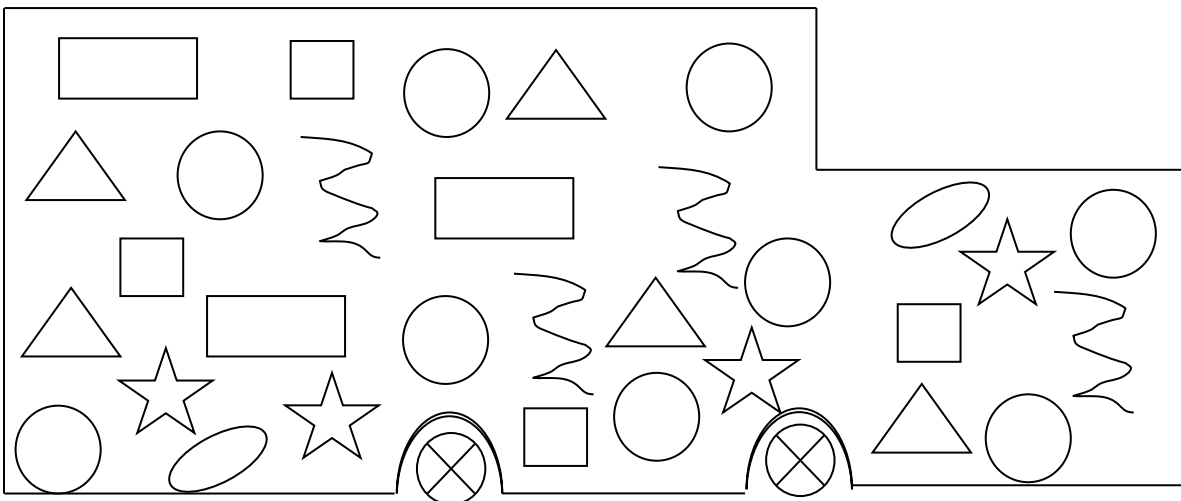

GERSHIBON CHRISTIAN SCHOOLS

HOMEWORK FOR MIDDLE CLASS TERM 1
NUMBER – LEARNING AREA 4 (Week 12)

My name is

Read and match

star

oval

rectangle

triangle

circle

square

zigzag

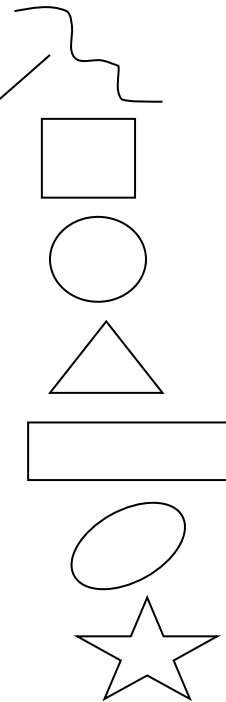

Write the numbers correctly

∞ = _____

9 = _____

└ = _____

b = _____

01 = _____

57 = _____

74 = _____

3 = _____

2 = _____

GERSHIBON CHRISTIAN SCHOOLS

HOMEWORK FOR MIDDLE CLASS TERM 1
NUMBER – LEARNING AREA 4 (Week 11)

My name is

Read and draw

Oval _____

triangle _____

Square _____

zigzag _____

Star _____

rectangle _____

Count and tick

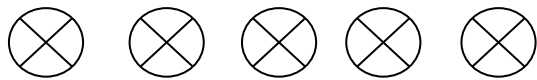

= 7 6 8

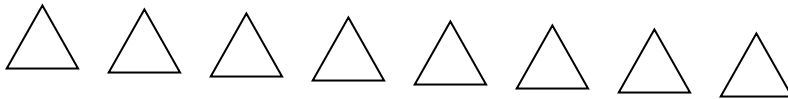

= 8 7 9

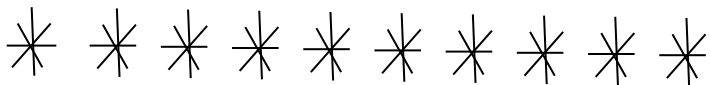

= 6 8 9

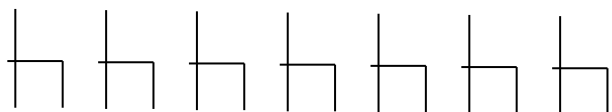

= 7 8 6

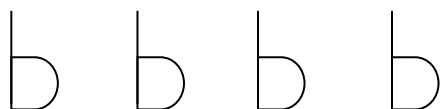

= 3 4 5

GERSHIBON CHRISTIAN SCHOOLS

HOMEWORK FOR MIDDLE CLASS TERM 1
NUMBER – LEARNING AREA 4 (Week 12)

My name is

Name the shapes

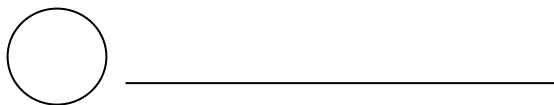
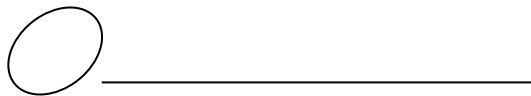
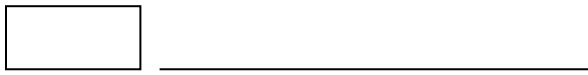

(oval, circle, zigzag, star, square, rectangle, triangle)

Draw pictures for the number.

4 = _____

7 = _____

2 = _____

0 = _____

9 = _____

6 = _____

8 = _____

3 = _____

GERSHIBON CHRISTIAN SCHOOLS

HOMEWORK FOR MIDDLE CLASS TERM 1 2015

WRITING No 1

My name is

Copy

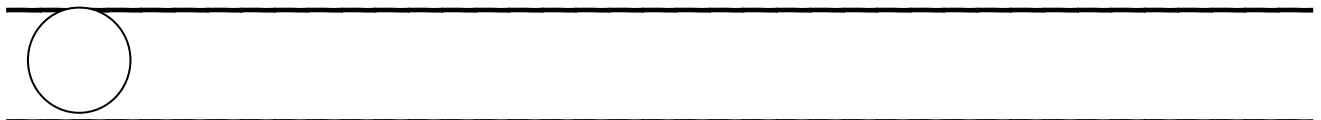

Draw your home.

My home



GERSHIBON CHRISTIAN SCHOOLS

HOMEWORK FOR MIDDLE CLASS TERM 1

WRITING (week two)

My name is

1. Copy and write

2. Draw and colour people at home.



GERSHIBON CHRISTIAN SCHOOLS

HOMEWORK FOR MIDDLE CLASS TERM 1

WRITING (No. 3)

My name is

1. Copy and write

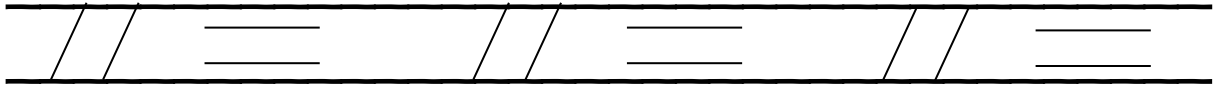

2. Colour your fingers.

GERSHIBON CHRISTIAN SCHOOLS

HOMEWORK FOR MIDDLE CLASS TERM 1

WRITING (No. 4)

My name is

1. Colour the pattern



2. Match the same picture.

GERSHIBON CHRISTIAN SCHOOLS

WRITING HOMEWORK FOR MIDDLE CLASS TERM 12015 No. 5

My name is

1. Copy and write

C C C C C

C

C

C

2. Match and draw the same picture.

GERSHIBON CHRISTIAN SCHOOLS

HOMEWORK FOR MIDDLE CLASS TERM 1

WRITING (No. 6)

My name is

1. Copy and write

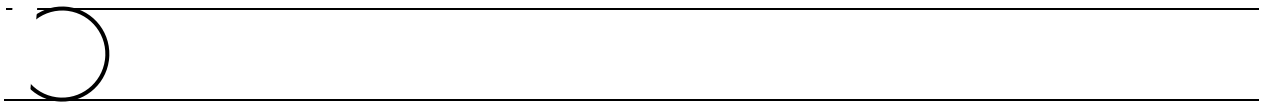
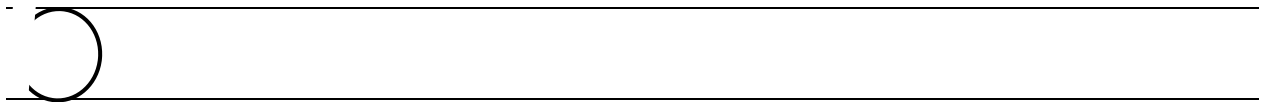
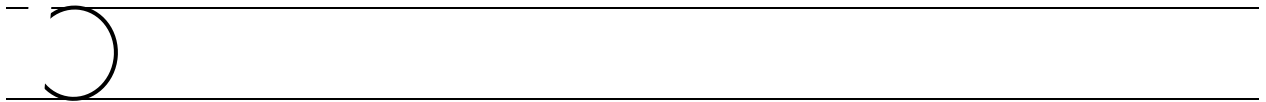
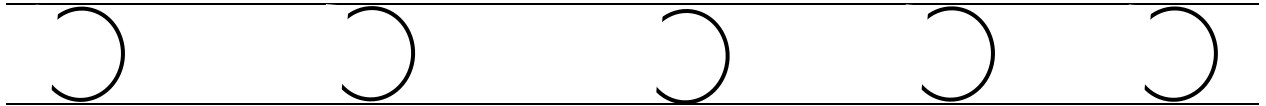

2. Match the same people at home.

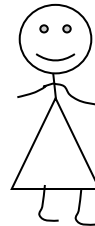
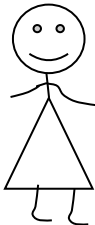
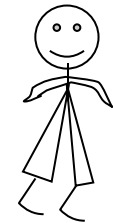

GERSHIBON CHRISTIAN SCHOOLS

HOMEWORK FOR MIDDLE CLASS TERM 1

WRITING (No. 7)

My name is

1. Copy and write

U U U U U U

U

U

U

2. Match the same word.

hen

pig

cow

sheep

dog

dog

sheep

cow

pig

hen

GERSHIBON CHRISTIAN SCHOOLS

HOMEWORK FOR MIDDLE CLASS TERM 1

WRITING (No. 8)

My name is

1. Copy and write

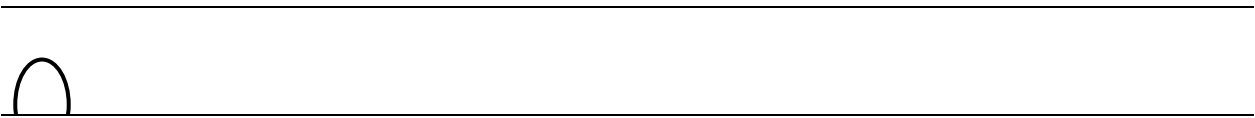

2. Complete the pattern.

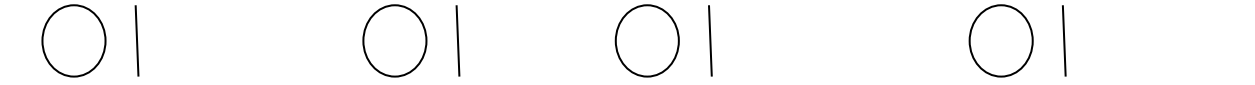

GERSHIBON CHRISTIAN SCHOOLS

HOMEWORK FOR MIDDLE CLASS TERM 1

ENGLISH (Week one)

My name is

Shade things found in class

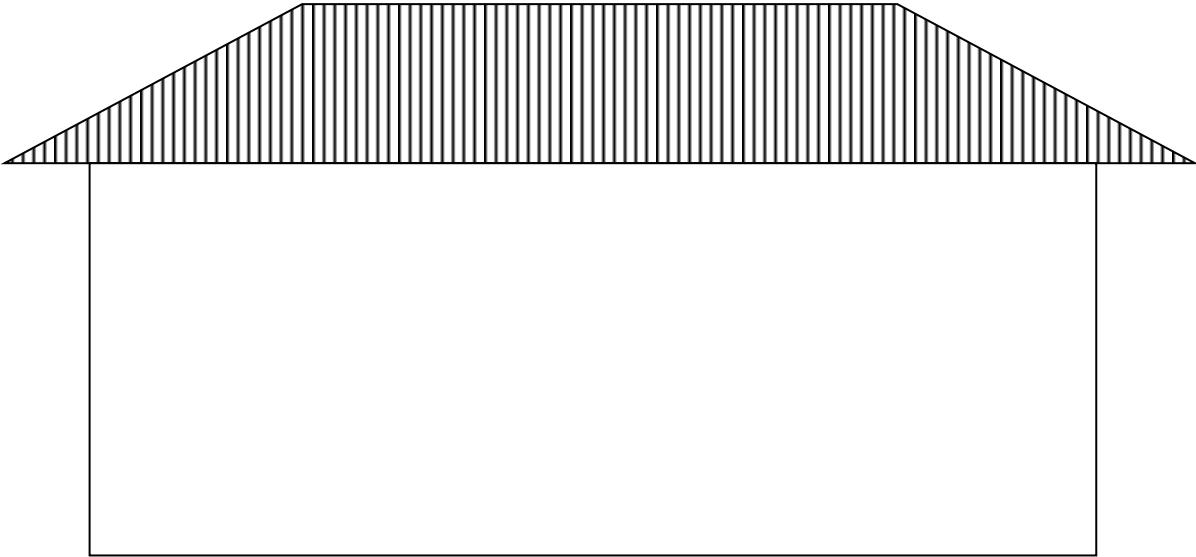

Match the things found in class.

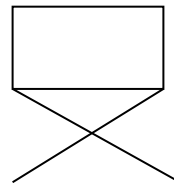
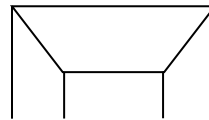
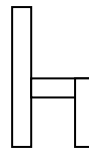
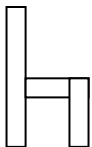
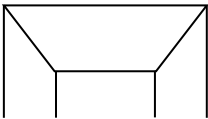
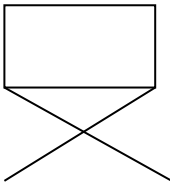

GERSHIBON CHRISTIAN SCHOOLS

HOMEWORK FOR MIDDLE CLASS TERM 1

ENGLISH (Week Two)

My name is

Match the same pictures and draw

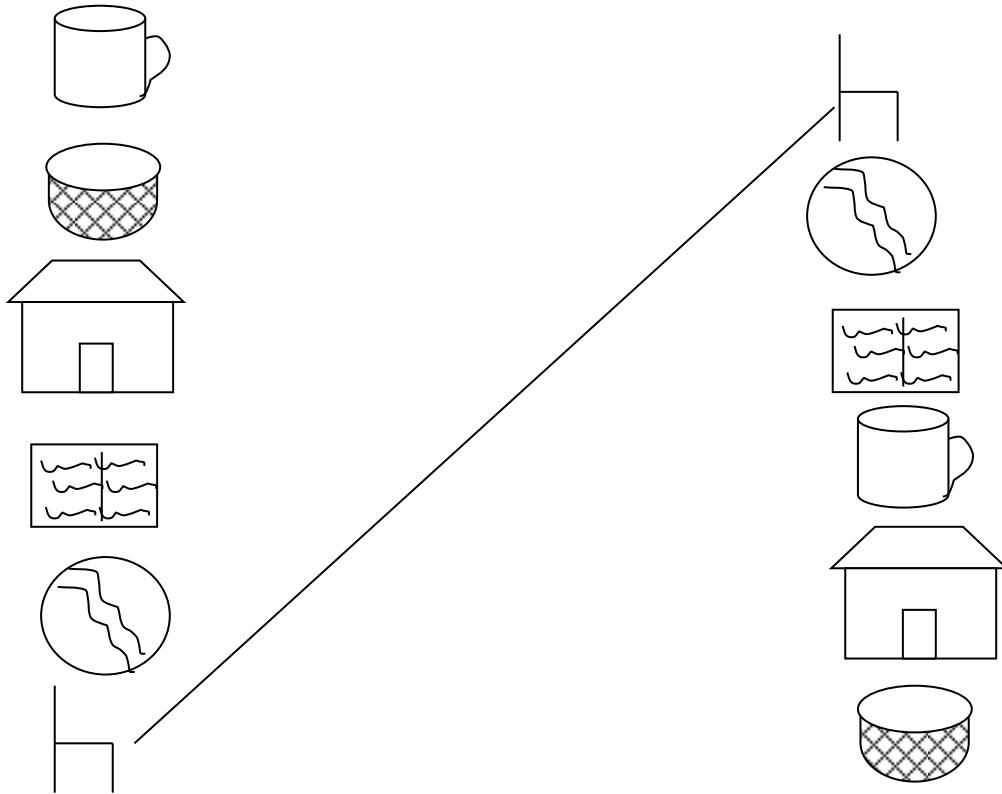

Colour the same pictures

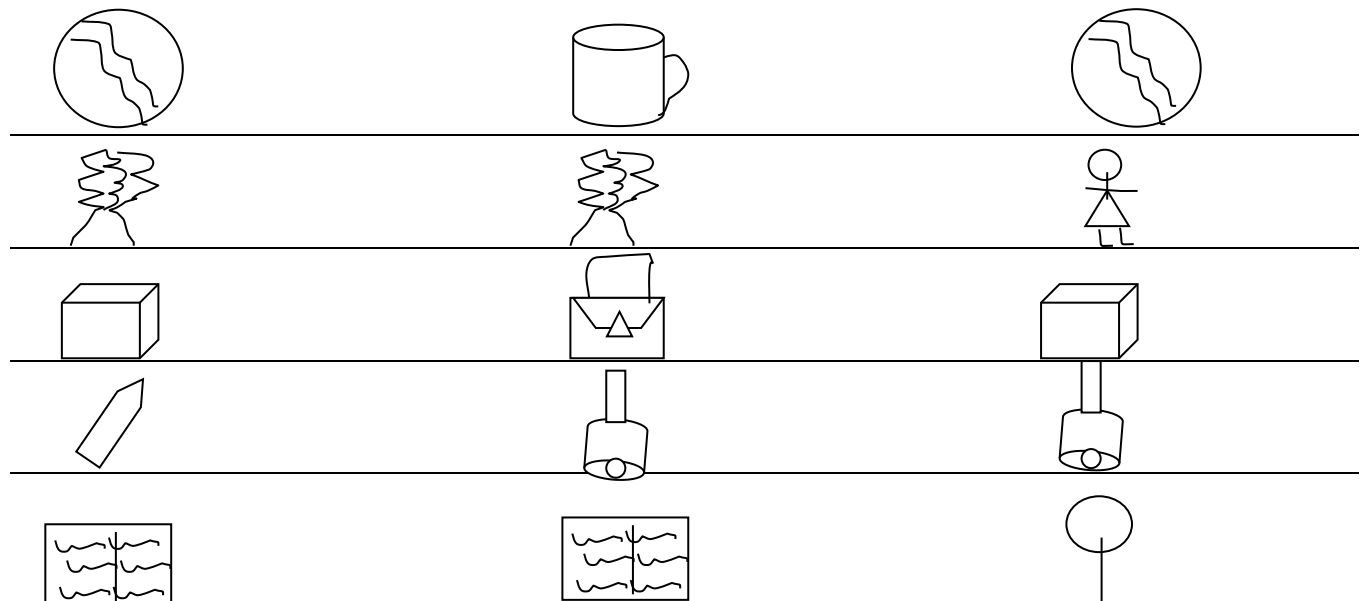







GERSHIBON CHRISTIAN SCHOOLS

HOMEWORK FOR MIDDLE CLASS TERM 1

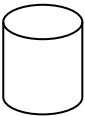

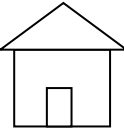
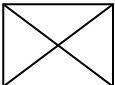
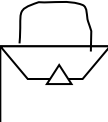

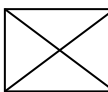
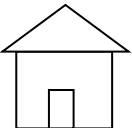
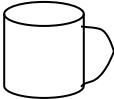
ENGLISH (Week 3)

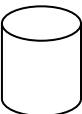
My name is

Match the same pictures and write

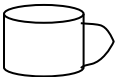
			Cat	_____
				_____
				_____
				_____
				_____
				_____

Circle the correct word

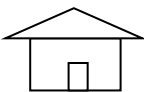
	cup	ucp
	int	tin
	box	obx
	peg	epg
	opt	pot
	hut	ntu

GERSHIBON CHRISTIAN SCHOOLS

HOMework FOR MIDDLE CLASS TERM 1

ENGLISH (WEEK 4)

My name is

Ring the correct picture

Underline the correct word



cup

bat

can



bag

tin

tap



car

box

gap

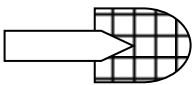

axe

peg

bat

tap

man

pin

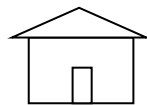

bed

hut

hoe

pot

boy

hen

GERSHIBON CHRISTIAN SCHOOLS

HOMEWORK FOR MIDDLE CLASS TERM 1

ENGLISH (week 5)

My name is

Name these

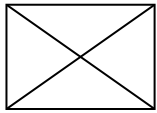

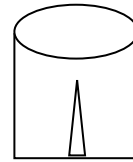

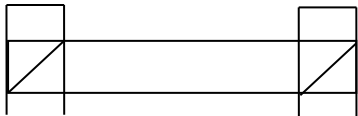

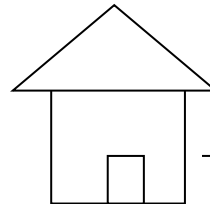

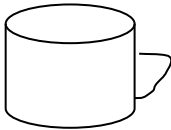

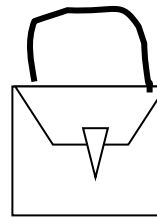

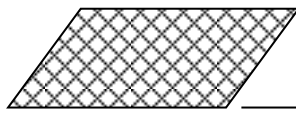

Cross the different word

cow mat cow

bag bag tin

pen tap tap

pot bed pot

cat cat bag

GERSHIBON CHRISTIAN SCHOOLS

HOMEWORK FOR MIDDLE CLASS TERM 1

ENGLISH (Week 6)

My name is

Read and match

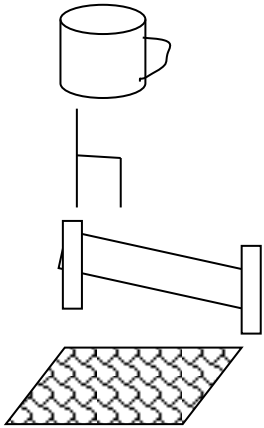

tin

pot

mat

cup

bed

chair

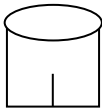
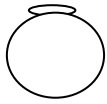

Read and draw

ball _____

bed _____

peg _____

tap _____

bat _____

mat _____

boy _____

egg _____

axe _____

GERSHIBON CHRISTIAN SCHOOLS

HOMEWORK FOR MIDDLE CLASS TERM 1

ENGLISH (Week 7)

My name is

Shade the biggest picture

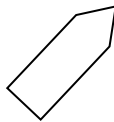
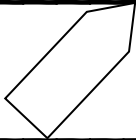
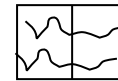
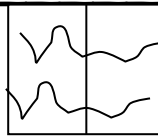
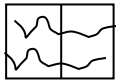
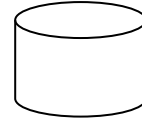
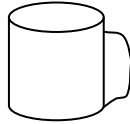

Write the words correctly



abg = _____

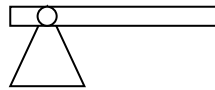

xea = _____

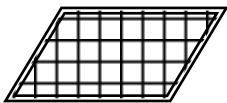

mta = _____

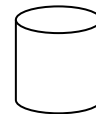

int = _____

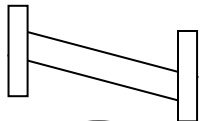

bde = _____

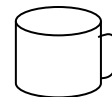

ucp = _____

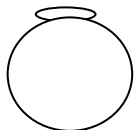

otp = _____











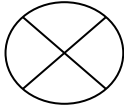
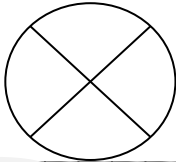

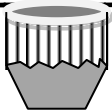
GERSHIBON CHRISTIAN SCHOOLS

HOMEWORK FOR MIDDLE CLASS TERM 1

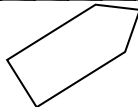

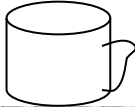

ENGLISH (Week 8)

My name is

Tick the smallest picture

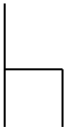
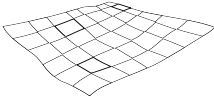
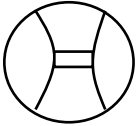
Name the pictures.

	_____		_____
	_____		_____
	_____		_____
	_____		_____

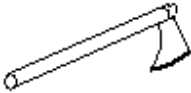
GERSHIBON CHRISTIAN SCHOOLS

HOMEWORK FOR MIDDLE CLASS TERM 1

ENGLISH (Week 9)

My name is

Match to the belonging

Read and draw

book _____

sun _____

tree _____

star _____

bag _____

chair _____

tree _____

house _____

GERSHIBON CHRISTIAN SCHOOLS

HOMEWORK FOR MIDDLE CLASS TERM 1

ENGLISH (week 10)

My name is

What is missing?

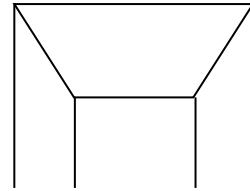
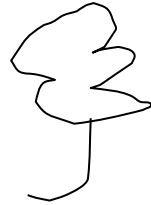
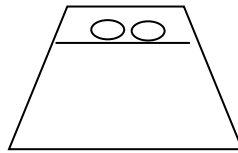
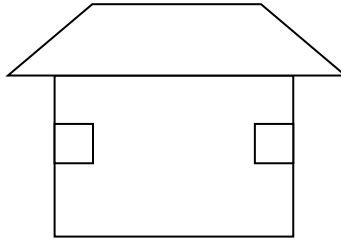
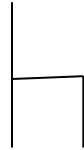
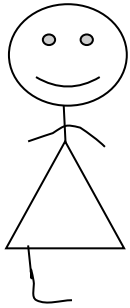

Circle the correct word

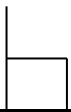

mat

bag

chair



tea

book

doll

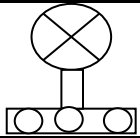

pot

fan

tree

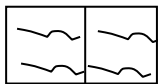

apple

stick

book



tree

ball

cat

GERSHIBON CHRISTIAN SCHOOLS

HOMWORK FOR MIDDLE CLASS TERM 1

READING (Week 1)

My name is

Shade me please

Copy the same

a	a	a	a
_____	_____	_____	_____
_____	_____	_____	_____
_____	_____	_____	_____

Read and copy

ant	axe

GERSHIBON CHRISTIAN SCHOOLS

HOMEWORK FOR MIDDLE CLASS TERM 1

READING (Week 2)

My name is

Shade the ball.

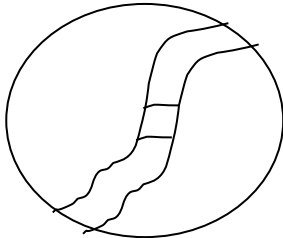

Copy letter sound b.

b

b

b

b

Read and copy

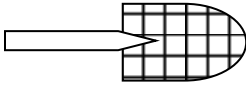
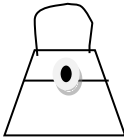
 <p>bat</p> <p>_____</p> <p>_____</p> <p>_____</p>	 <p>bag</p> <p>_____</p> <p>_____</p> <p>_____</p>
---	--

GERSHIBON CHRISTIAN SCHOOLS

HOMework FOR MIDDLE CLASS TERM 1

READING (Week 3)

My name is

Colour the cat

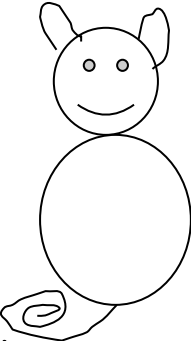

Copy letter sound c.

c

c

c

c

Read and learn

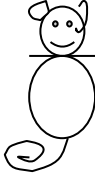
	cup		Cat

GERSHIBON CHRISTIAN SCHOOLS

HOMework FOR MIDDLE CLASS TERM 1

READING (Week 4)

My name is

Shade the doll.

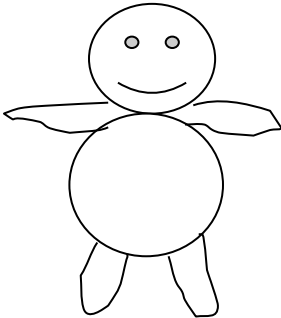

Copy letter sound d.



d

d

d

d

Read and learn

 doll	 door

GERSHIBON CHRISTIAN SCHOOLS

HOMEWORK FOR MIDDLE CLASS TERM 1

READING (Week 5)

My name is

Shade me please

Copy letter sound f.

f

f

f

f

Read and copy

fish	fan
_____	_____
_____	_____
_____	_____

GERSHIBON CHRISTIAN SCHOOLS

HOMework FOR MIDDLE CLASS TERM 1

READING (Week 7)

My name is

Shade the glass.

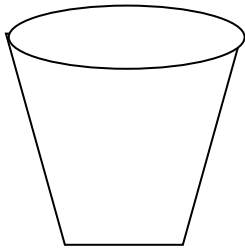

Copy letter sound g.



g

g

g

g

Read and copy

	girl		glass

GERSHIBON CHRISTIAN SCHOOLS

HOMEWORK FOR MIDDLE CLASS TERM 1

READING (Week 8)

My name is

Copy letter sounds a - f

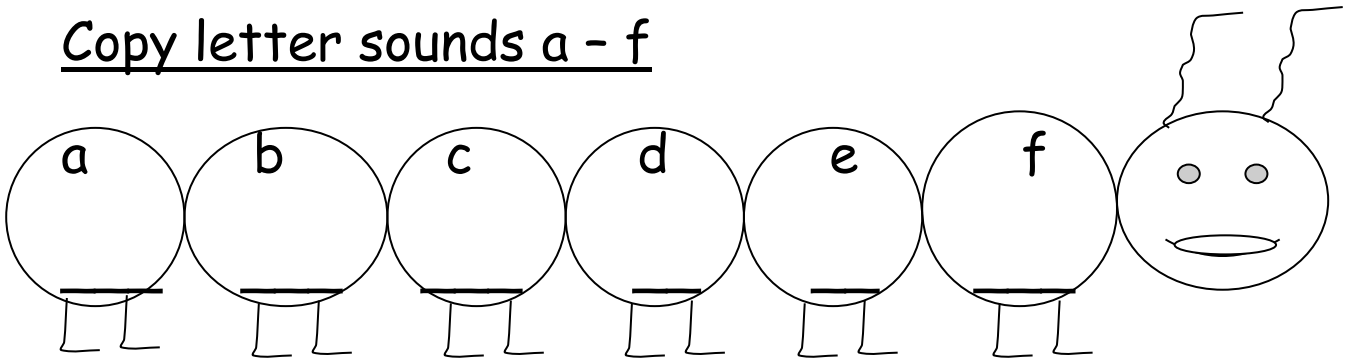

Match the same letter sounds and draw the

pictures.

a

e

b

d

c

f

g

g

f

c

a

e

b

d

GERSHIBON CHRISTIAN SCHOOLS

HOMework FOR MIDDLE CLASS TERM 1

READING (Week 9)

My name is

Circle the correct letter sound

a o o o

o o b o

f f t j

Match letter sound to picture and colour

b



e



f



a



c

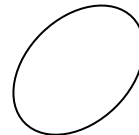

g

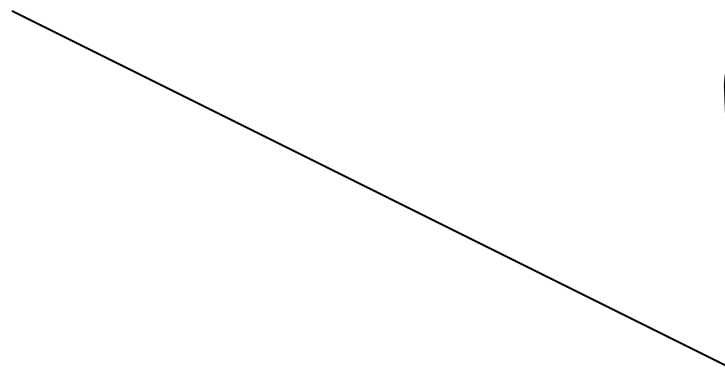
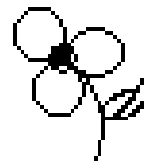

GERSHIBON CHRISTIAN SCHOOLS

HOMEWORK FOR MIDDLE CLASS TERM 1







READING (Week 9)

My name is

Tick the given letter sound.

d	z	z	d ✓
e	m	e	m
c	t	t	c
b	d	b	d

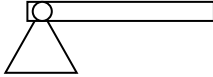
Cross the correct letter sound for the picture.

	a	b	e
	h	g	j
	e	a	f
	m	f	n
	r	s	a
	d	b	n
	c	b	d

GERSHIBON CHRISTIAN SCHOOLS

HOMEWORK FOR MIDDLE CLASS TERM 1

READING (Week 10)

My name is

Cross the different letter sound

b d b b

c c c a

e e i e

o a a a

Draw pictures for the letter sound.

h _____

c _____

b _____

d _____

e _____

f _____

Shade pictures of letter sound "b"

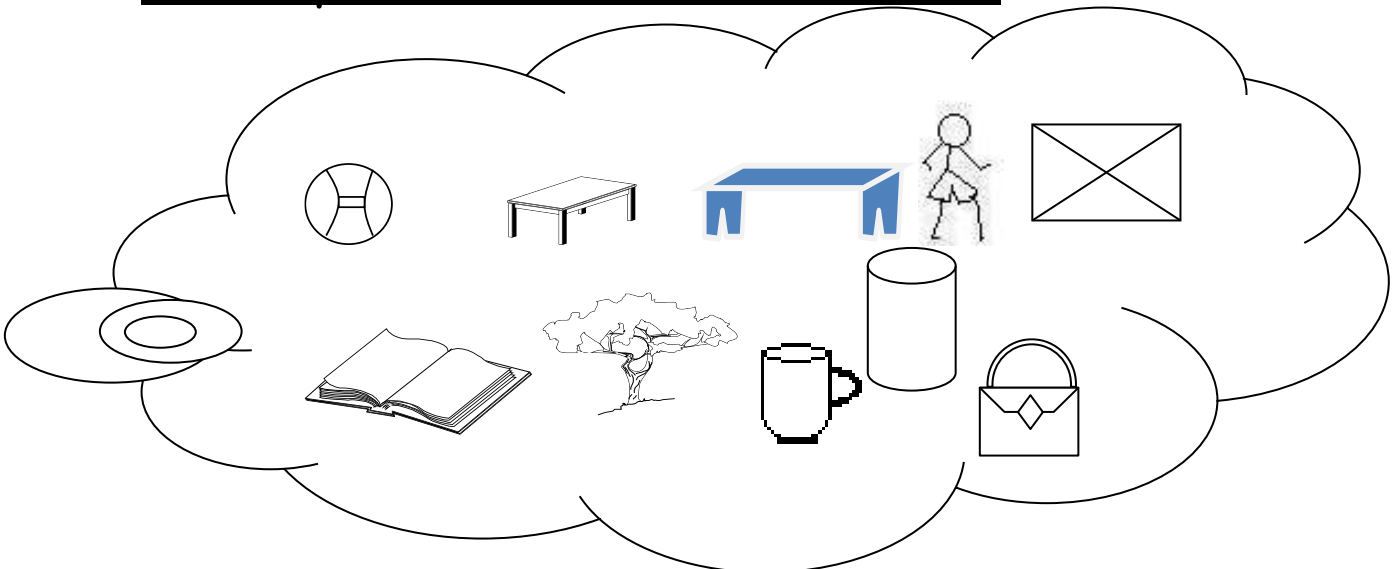

GERSHIBON CHRISTIAN SCHOOLS

HOMEWORK FOR MIDDLE CLASS TERM 1

READING (Week 11)

My name is

Fill in the missing letter sound "a"

b__t

b__g

t__p

p__n

m__t

c__t

h__t

c__r

Match letter sound to word

a

hat

b

gap

c

axe

e

bag

f

cat

g

egg

h

fan

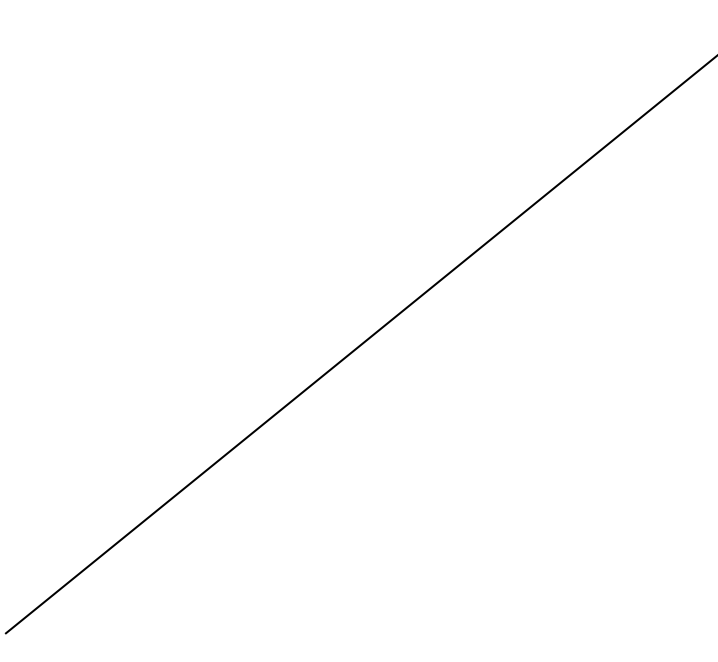

GERSHIBON CHRISTIAN SCHOOLS

HOMEWORK FOR MIDDLE CLASS TERM 1

READING (Week 12)

My name is

Read and draw

bag _____

tin _____

cat _____

man _____

pot _____

tree _____

book _____

chair _____

Match letter sound to picture

b

c

e

f

a

g

h