

YUDESI NURSERY AND PRIMARY SCHOOL

P.5 MATHEMATICS HOLIDAY PACKAGE TERM 1, 2020

Name: _____ Stream: _____

SET CONCEPTS:

1. Given the sets A and B.

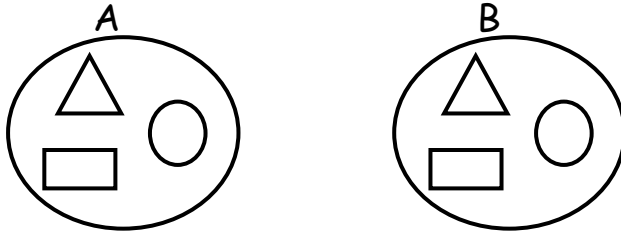

Set A and B are _____ sets.

2. What name is given to the set symbol below?

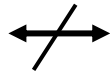

3. Shade $A - B$ on the venn diagram below.

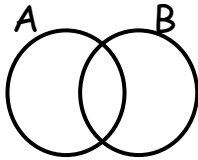

4. If $A = \{a, b, c, d, e, f\}$ and $B = \{a, e, i, o, u\}$. Find $n(A \cap B)$

5. Given that $C = \{\text{apple, yam, orange, mango, pawpaw}\}$ and $D = \{\text{lemon, yam, apple, ovacado}\}$.

Write down all the elements of set $(C \cap D)'$

6. Set $Y = \{4, 6, 8\}$. List all the subsets that can be formed from set Y.

7. How many subsets can you get from a set with 5 elements?

8. Draw a venn diagram to show that all Cows (C) are Animals (A)

9. What is the relationship between set V and W given below?

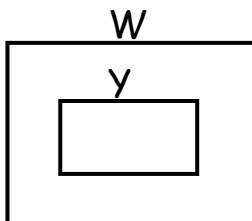

10. A boy rolled a die once, what is the probability that an even number showed up?

11. Write the place value of each digit in the number 240,536.
12. Find the value of the underlined digits in $6\underline{4}83\underline{5}7$
13. Write 908,047 in words.
14. Write two thousand twenty in figures.
15. Use the digits 4, 0, 2 and 6 to form the smallest 4 digit number.
16. Expand 4,567 using powers of 10.
17. Write $(3 \times 10^4) + (5 \times 10^2) + (7 \times 10^0)$ in short form.
18. Round off 59,684 to the nearest thousands.
19. Convert 294 to Roman numerals.
20. Change CXLVIII to Hindu Arabic numerals.

SECTION B;

- 21a) Add 345,678 to 504,963
- b) Takeaway 532,167 from 724,823
- c) What is the product of 456 and 24?
- d) Workout $2 \overline{)2496}$

22a) Study the venn diagram below and use it to answer questions that follow.

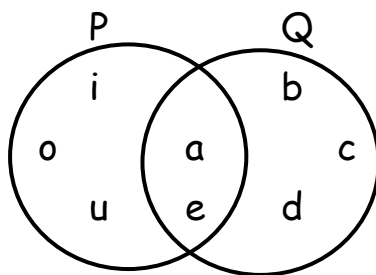

- a) List the elements of set;
 - i) Q
 - ii) $P - Q$
 - iii) $P \cap Q$
- b) Find;
 - i) $n(P \cup Q)$
 - ii) $n(P)$
 - iii) $n(Q - P)$

23. Use the venn diagram below to answer questions that follow;

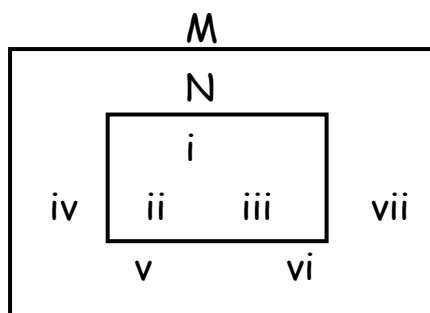

- a) What is the relationship between set N and M?
- b) List the elements of;
- i) N ii) M iii) M - N
- c) Find;
- i) $n(\text{NUM})$ ii) $n(M \cap N)$

24. Study the venn diagram below and use it to answer questions that follow;

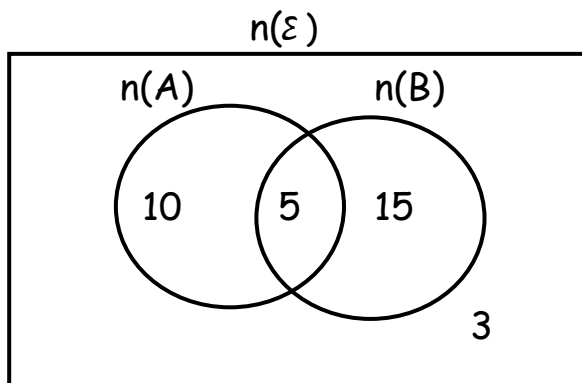

Find;

- i) $n(A)$ ii) $n(B)$ iii) $n(\epsilon)$
- iv) $n(A \cap B)'$ v) $n(A)'$ vi) $n(A \cup B)'$
25. In a box, there are 6 red pens, 4 blue pens and 5 green pens.
What is the probability of picking;
- a) a blue pen?
- b) a red pen?
- c) a green pen?
- d) a blue or a red pen?
- e) a purple pen?
- f) a green, blue or red pen?
26. Given the number 45,879;
- a) Expand the above number using values.
- b) Write the above number in words.
- c) Find the value of 5 in the above number.
- d) What is the sum of the place value of 4 and 8 in the above number?
- e) Find the difference between the value of 5 and 7 in the given number.

f) Workout the product of the value of 7 and the place value of 8 in the given number.

27. A P.5 child was given the following cards

6

3

2

 and

7

 to form four (4) digit numbers.

a) Write down the;

i) smallest number formed.

ii) largest number formed.

b) Find the difference between the smallest and largest number formed.

c) What is the sum of the smallest and largest number formed?

d) Show the smallest number formed on an abacus.

e) Expand the largest number formed using place values.

28a) The National Disaster Preparedness Department supplies food to people in the camps each week 36,739 kg of food were supplied in the 1st week, 234,565kg in the 2nd week and 104,053 kg in the 3rd week. How many kilograms were supplied altogether?

b) Nakato was paid sh.500,000 for a task she did. She gave her brother sh.185,000. How much was she left with?

c) The KLM air transport company makes 184 flights every week. How many flights does the company make in 52 days?

d) The area of a rectangular piece of land is 10,000 square metres. If the width is 50 metres, calculate its length.

e) Workout $3 \times 4 + 5$

f) Evaluate $8 - 6 + 5$

29. Study the figure and answer questions about it correctly.

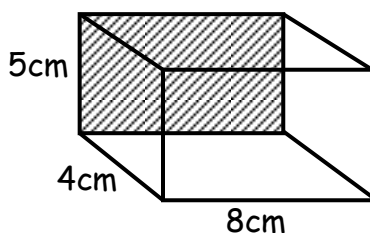

a) What name is given to the figure above?

b) Find its number of;

i) faces

ii) edges

iii) vertices

c) What is its volume?

d) Calculate the area of the shaded part.

30a) Write $\frac{2}{5}$ in words.

b) What is the next equivalent fraction?

$$\frac{2}{3}, \frac{4}{6}, \frac{6}{9}, \frac{8}{12}, \underline{\hspace{2cm}}$$

c) Add; $\frac{2}{5} + \frac{3}{5} =$

d) Find and fill in the missing number;

$$\frac{1}{4} = \frac{\boxed{}}{16}$$

e) Subtract $\frac{1}{3}$ from $\frac{1}{2}$

f) Shade $\frac{3}{4}$ of

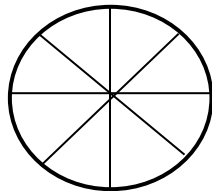

31a) Solve for p; $p + 14 = 20$

b) Find the value of m; $m - 73 = 17$

c) Solve; $2m = 16$

d) Workout $w \div 4 = 8$

e) Find the value of the unknown angles in;

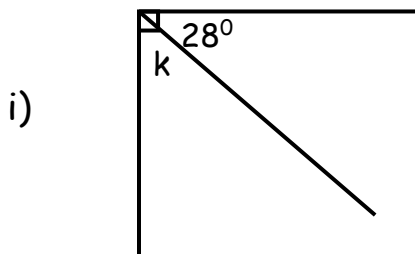

ii)

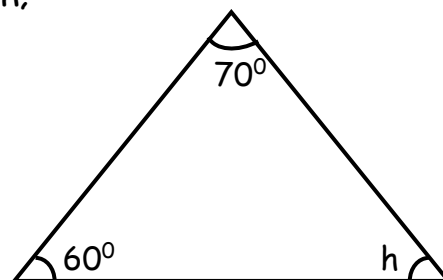

32. Given that $a = b = 5$ and $c = 4$

Find the value of;

i) $a + b + c$

ii) abc

iii) $2a - c$

iv) c^2

v) $\frac{bc}{2}$

vi) $c - b$